

The InLine Cleaning System : More power, more features, less space

Custom, Adaptable Design

InLine machines are designed by experts in the industry to fit comfortably in any manufacturing process. And every machine is mobile and adaptable to accommodate changing manufacturing processes and cleaning needs. Visit our website at www.inlinecleaning.com or call us to tell us about your process. We'll design and build a machine for you.

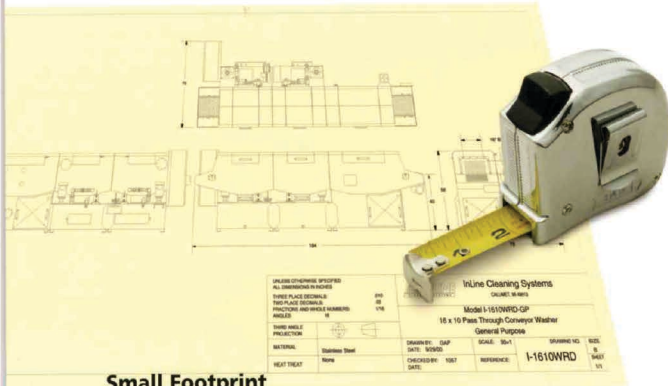

Small Footprint

InLine machines pack more features and more cleaning power into a small, extremely efficient package for unmatched overall efficiency. InLine is the answer for cost-effective pass-through cleaning.

Environmentally Friendly

InLine machines minimize environmental impact. Every machine uses a closed-loop wash system to consume less water, includes a standard automatic oil skimmer to remove petroleum-based products from the wash solution, and is available with exclusive, biodegradable InLine detergents and additives.

Industry Experience

InLine Cleaning Systems™ is a division of the largest manufacturer of water-based cleaning technology in the U.S. InLine machines leverage decades of water-based cleaning experience to combine the latest materials, technologies, and design techniques to provide you with the fastest, most powerful, and most efficient cleaning solutions available.

The plant photo on the cover shows a stainless steel InLine 2420 Series machine that was custom-designed to fit seamlessly into an existing manufacturing process. The machine eliminated the need to transfer parts to a separate cleaning station, thereby dramatically reducing production time and costs.

Robust, Precision-Engineered Electrical System

The electrical panel is carefully designed using a clean, uncluttered layout and the finest industrial-grade components. From simple relay logic to sophisticated PLC, each system is designed to precisely monitor and control every operating function.



Convenient Ergonomic Design

The infeed and outfeed decks are a comfortable 38 or 41 inches off the floor to minimize stooping and lifting. The maximum standard tunnel capacity is 24 inches wide by 20 inches high; machines with tunnel capacities of up to 48 inches wide by 48 inches high are also available. Conveyor belts are available in galvanized steel, stainless steel, or a variety of plastic materials. Conveyor speed is adjustable from 0 to 20 feet per minute.



High-Volume Precision Cleaning and Rinsing

The standard wash and rinse stages use high-capacity pumps and rapid-response heating elements to thoroughly flood parts with high volumes of hot wash and rinse solution. The precisely engineered multi-direction spray patterns provide 360° part coverage, aggressively scrubbing and rinsing parts clean in seconds.



Continuous Large-Particle Filtration

The patented front-access debris screen continuously filters debris particles from the cleaning solution to ensure blockage-free spray nozzle operation. The screen also provides a safeguard against small parts that might accidentally be blasted through from the wash chamber.



All InLine machines are available with the following labor-saving, performance-enhancing

Options & Accessories

■ **Stainless Steel** is much more durable than mild steel. All InLine machines with rinse and dry stages use stainless steel for wetted parts. For increased strength, longer life, and greater compatibility with harsh cleaning and treatment processes, you can upgrade any machine entirely to stainless steel.

■ **The power steam vent** removes water vapor from the machine processing chambers, and prevents the build up of excess humidity in the surrounding work area. Using a power steam vent significantly improves drying efficiency.

■ **The recirculating air option** continuously recycles the air in the drying chamber, which keeps the drying air warmer and cleaner. Used in conjunction with the power steam vent, the recirculating air option results in more efficient drying and less frequent air filter replacement.

■ **The filtration system** continuously filters solid particles from the wash solution, which results in more efficient cleaning performance. You can use the **Sump Sweep™** system to periodically remove waste build up from the bottom of the sump.

■ **The digital temperature and conveyor speed controllers** allow you to precisely set the wash and rinse solution temperatures, and the speed of the conveyor. The controllers include LED readouts on the control panel, which allow you to visually monitor the temperature and speed at a glance.

■ **InLine's adjustable guide rail system** positions your parts to achieve the exact cleaning results you need. Each guide rail system is custom-designed for your application, and is fully adjustable to accommodate all of your parts.

■ **The adjustable feeder chute** gravity-feeds parts onto the conveyor for hands-free machine operation. InLine offers custom-designed feeder chutes to enable integration into any manufacturing process.

■ **At InLine, we carefully blend our own biodegradable detergents and additives** to ensure the highest performance in the industry. Our detergents include a proprietary blend of powerful organic and synthetic cleaning agents, a compound corrosion inhibitor system, and special anti-foaming agents.



High-Efficiency Drying

The standard dry stage uses a high-velocity centrifugal blower and two or four strategically placed air knives to generate 600 to 1200 CFM of clean air for rapid drying. And easy-access butterfly valves allow precise air flow adjustment.



Enclosed Design

The blower motor is fully enclosed behind large, easy-access panels beneath the outfeed deck. Enclosing the motor cuts down on noise, reduces intake filter contamination, and creates a smaller, cleaner machine footprint.



Automatic Oil Skimmer

The integrated high-capacity oil skimmer effectively removes petroleum products from the cleaning solution. The removable collection container provides a means for convenient waste collection and disposal.

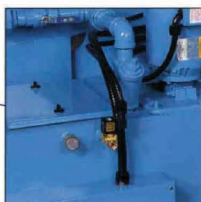

Auto-Fill and Low-Water Safety Systems

The auto-fill and low-water safety systems automatically monitor and maintain wash solution levels in the sump chamber. The auto-fill system ensures that the wash solution remains at optimum levels. The low-water safety system disconnects power to the heating elements to prevent overheating or element burnout if the wash solution drops below safe levels.



InLine: A Better Way to Clean

InLine industrial parts washers pack more cleaning performance per linear foot than any other system in the industry. Every InLine machine is specifically engineered to clean more parts more effectively using less time, less space, and less energy.

The optional filtration system enhances cleaning performance and reduces maintenance requirements by continuously filtering the wash solution.

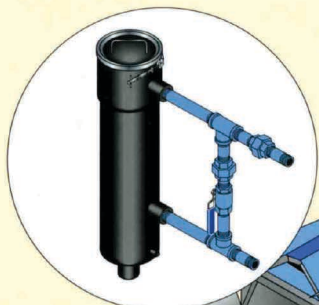

Wash and Rinse Stages

The wash and rinse stages use a fraction of the space typically required of a conveyor wash system. Combining the optimum balance of pressure, temperature, and flow with a precisely engineered spray nozzle configuration, they clean and rinse your parts thoroughly and efficiently.

Dry Stage

The dry stage, using a high-speed centrifugal blower, is significantly more efficient than evaporative systems. The blower delivers clean air to the strategically placed air knives. The air knives focus the air – at a velocity of up to 400 MPH – directly on parts, creating an extremely efficient “squeegee action,” and drying parts in seconds.

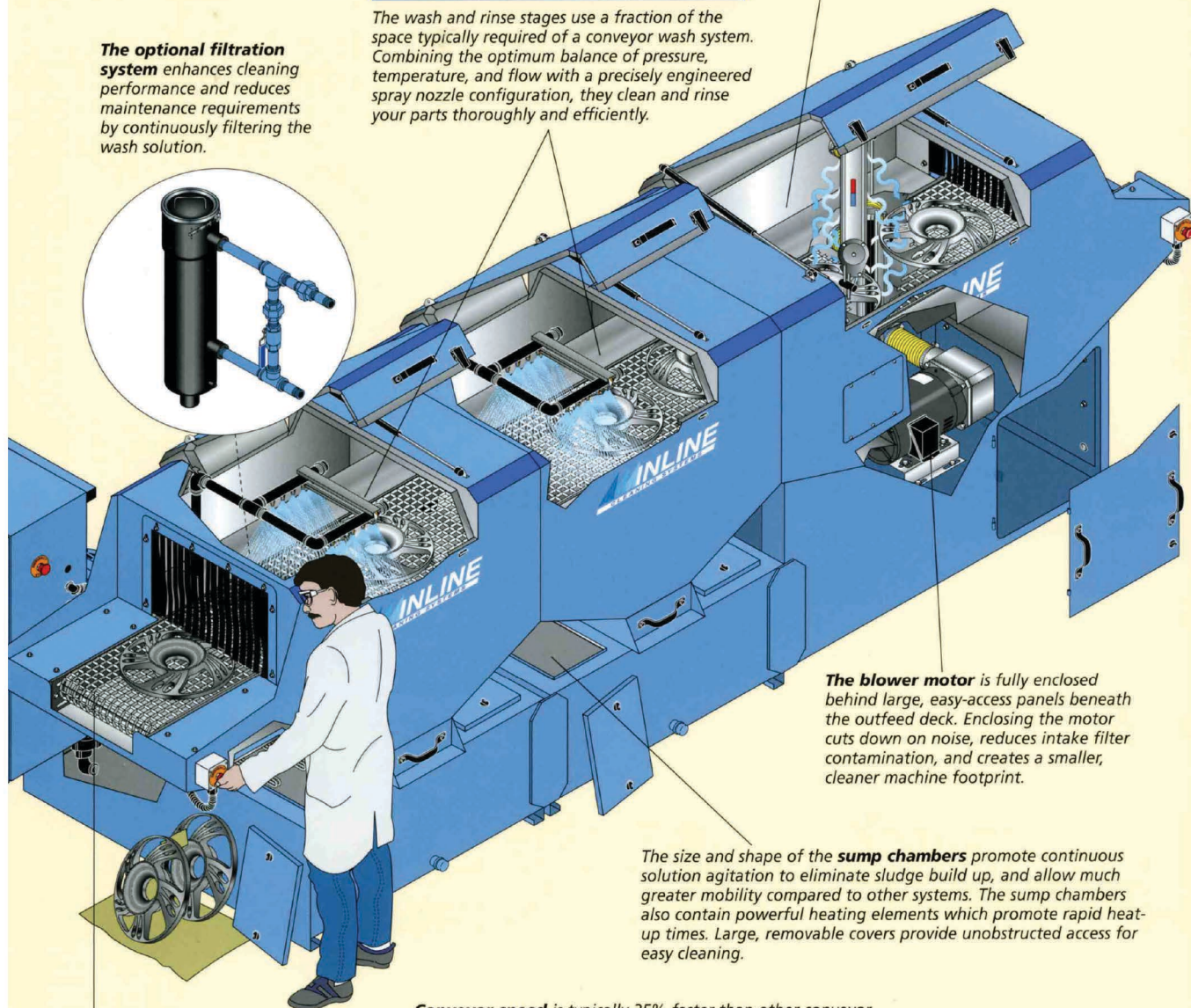

The blower motor is fully enclosed behind large, easy-access panels beneath the outfeed deck. Enclosing the motor cuts down on noise, reduces intake filter contamination, and creates a smaller, cleaner machine footprint.

The size and shape of the sump chambers promote continuous solution agitation to eliminate sludge build up, and allow much greater mobility compared to other systems. The sump chambers also contain powerful heating elements which promote rapid heat-up times. Large, removable covers provide unobstructed access for easy cleaning.

Conveyor speed is typically 35% faster than other conveyor wash systems, made possible by the powerful wash and rinse stages which thoroughly clean and rinse in seconds, not minutes. An optional feeder chute is available for hands-free operation, and optional adjustable guide rails are available



InLine has the machine to meet your specifications...

Typical Configurations

InLine 1610 Series Parts Washers

Tunnel Capacity: 16 inches wide by 10 inches high

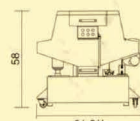

I-1610W-GP One-Stage (Wash)

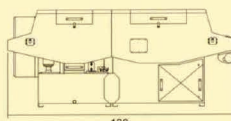

I-1610WD-GP Two-Stage (Wash/Dry)

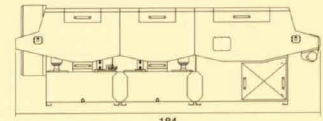

I-1610WRD-GP Three-Stage (Wash/Rinse/Dry)

InLine 2412 Series Parts Washers

Tunnel Capacity: 24 inches wide by 12 inches high

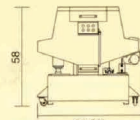

I-2412W-GP One-Stage (Wash)

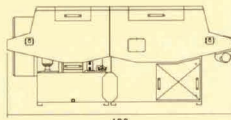

I-2412WD-GP Two-Stage (Wash/Dry)

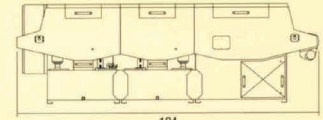

I-2412WRD-GP Three-Stage (Wash/Rinse/Dry)

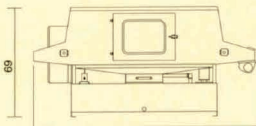

I-2420W-GP One-Stage (Wash)

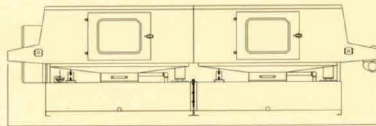

I-2420WD-GP Two-Stage (Wash/Dry)

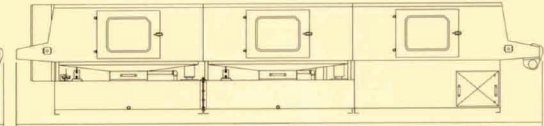

I-2420WRD-GP Three-Stage (Wash/Rinse/Dry)

InLine 2420 Series Parts Washers

Tunnel Capacity: 24 inches wide by 20 inches high

All measurements above shown in inches.

For information about custom machines with tunnel capacities of up to 48 inches wide by 48 inches high, contact your InLine representative, or visit our website at: www.inlinecleaning.com

The InLine Design Process

If your cleaning needs are fairly simple, a standard machine may be a perfect fit. If your needs are a bit more complex, or if you have special applications, call the InLine sales office. They will direct you to the InLine representative in your area.

At InLine, we don't expect anyone to adapt their manufacturing process to any specific machine. We'll help engineer an InLine machine to fit your specific needs.

InLine assures your satisfaction with:

- **An initial meeting** with one of our factory-trained representatives to determine your needs.
- **A lab test** of your parts at our factory to determine your cleaning requirements, and a detailed report with a video tape to describe the results and our recommendations.
- **Customer-coordinated design and development** – we build the machine to perform exactly as you want it to perform, and to fit exactly where you want it to fit.
- **A final run-off** at our factory before delivery to ensure optimum cleaning performance and seamless integration in your facility.

In the end you get exactly what you need; and it fits perfectly. The InLine Cleaning System: more power and features in a machine that takes less space. Contact the InLine sales office today, and take the first step toward experiencing the InLine Cleaning System.

